

IPC-7132

Cost-effective Wallmount Chassis for ATX/mATX Motherboard and 10-slot Backplane

NEW

PICMG 1.3



Features

- Supports ATX/mATX MB and 10 slot Backplane
- Shock-resistant to hold one 5.25" ODD and three 3.5" HDD
- Supports optional two 2.5" HDD within one 3.5" mobile HDD tray
- Thumb-screw design for top cover opening easily
- Optional PS/2 80 plus bronze 300W/400W power supply
- Bi-directional options to mount chassis on the wall or workbench

CE FCC RoHS COMPLIANT PRODUCT

Specifications

Disk Drive Bay	3.5"	Front-accessible	1	Internal	2
	5.25"		1		-
Cooling	Fan		1 (12 cm/85 CFM)		
	Air Filters		Yes		
Front I/O interface	USB		2		
	LED Indicators		Power, HDD		
Miscellaneous	Control		Power Switch, System Reset Button		
	Rear panel		4x USB, 2x DB-9, 1x LPT port		
			Operating		Non-operating
Environment	Temperature		0 ~ 40° C (32 ~ 104° F)		-20 ~ 60° C (-4 ~ 140° F)
	Humidity		10 ~ 85 % @ 40° C, non-condensing		10 ~ 95 % @ 40° C, non-condensing
	Vibration (5-500 Hz)		1G		2 G
	Shock		10 G (with 11 ms duration, half sine wave)		
Physical Characteristics	Dimensions (W x H x D)		200 x 330 x 430 mm (7.9" x 13" x 16.9")		
	Weight		9.96 kg (21.93 lb)		

Front view

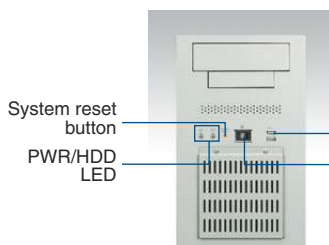

Inside view

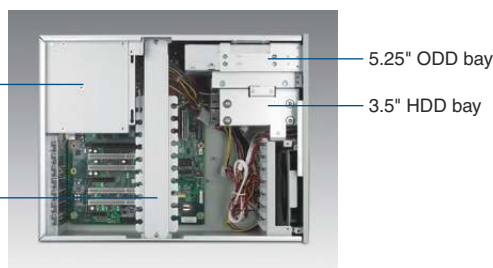

IPC-7132MB

Rear view

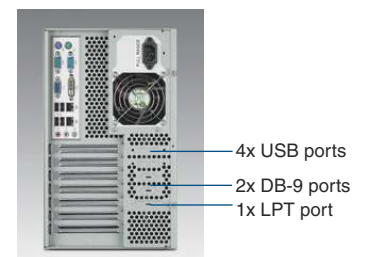

IPC-7132MB



Easy-to-maintain cooling fan

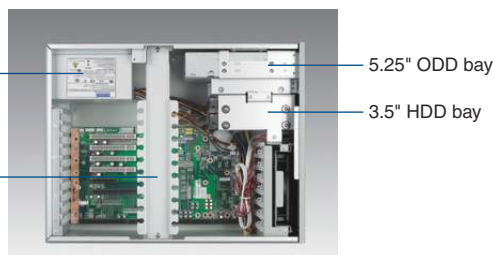

IPC-7132BP

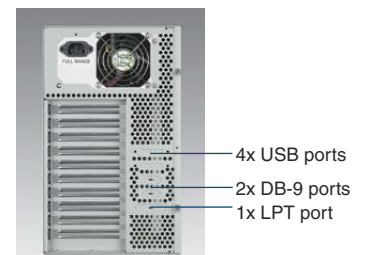

IPC-7132BP

Dimensions

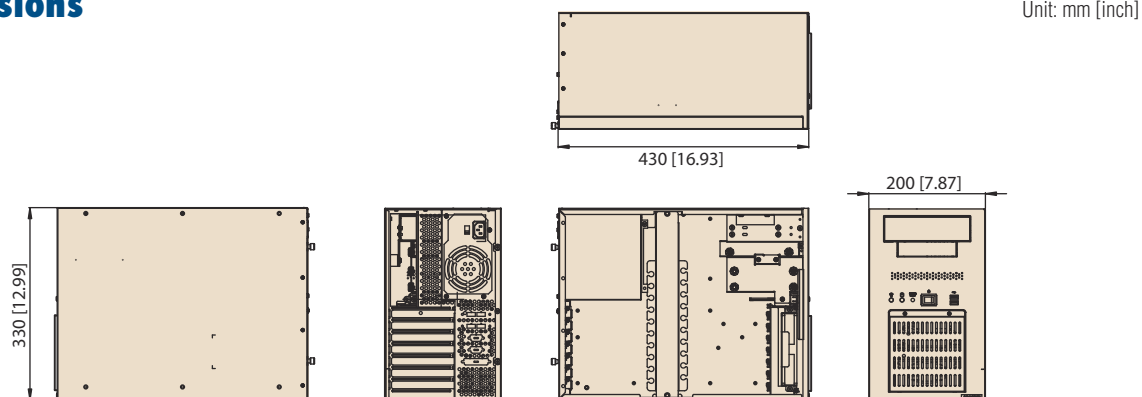

Installation

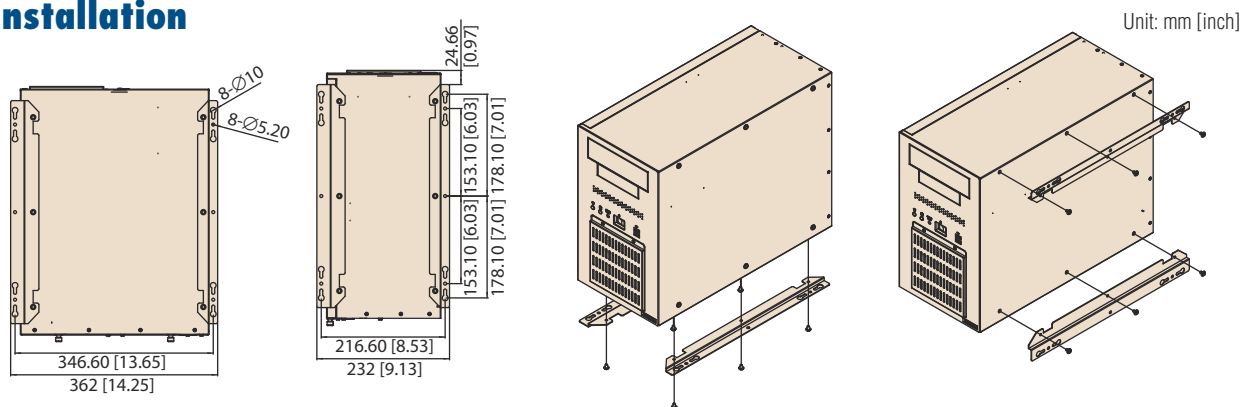

Ordering Information

Model name	Power Supply
Motherboard Version	
IPC-7132MB-00XE	Without power supply, with ATX switch
Backplane Version	
IPC-7132BP-00XE	Without power supply, with ATX switch

Backplane Options

Model	PICMG 1.3	PCIe	PCI-X	PCI
PCE-5B09-06A1E	PICMG 1.3	1 (PCIe x4)	-	6
PCE-5B09-04A1E	PICMG 1.3	3 (PCIe x4)	-	4

Power Supply Options

Part number	Watt	Input
PS8-300ATX-ZBE (ATX,PFC)	300 W	AC 100 ~ 240 V (full range)
PS8-400ATX-ZE (ATX,PFC)	400 W	AC 100 ~ 240 V (full range)

Optional Accessories

Part Number	Description
IDT-3120E	Mobile HDD tray for dual 2.5" SATA HDDs
1750006427	87.87 CFM, system fan 120 x 120 x 25.0 mm
1990001392	Filter cover for IPC-7220 A1